



User Manual





Table of contents

1. Safety & Compliance	4
2. Printing Materials	5
3. Overview	6
4. First Set Up	7
5. Main Menu	10
6. 3D Printing	11
7. Changing A Filament	13
8. Settings	15
9. Setting Up A Network Connection	16
10. Levelling The Printing Platform	17
11. Maintenance	18
12. Specifications	18
13. Troubleshooting	19
14. Contact	20



WELCOME

Hello!

Thank you for choosing the Skriware 3D Printer. You are now the proud owner of a product that took countless hours of our loving labour, dedication and passion. Hopefully using it will be as fulfilling for you, as building it, was for us. To make it possible we packed your Skriware 3D Printer full of advanced features and functions. We also strived to make it as user-friendly as possible but in order for you to seamlessly enjoy all that your Skriware 3D Printer has to offer, we strongly advise that you acquaint yourself with this manual.

1. Safety & compliance



Children supervision

We made Skriware 3D Printer easily accessible but due to the possible hazards listed below children should only use it under adult's supervision.



Risk of burns

Skriware 3D Printer itself operates in a safe temperature spectrum but some of its parts can get extremely hot (up to 235°C/ 455°F). Never touch the **hotend** or **extruder** and its vicinities while you can see the **HOT!** symbol on the **display**. These parts can stay hot up to 30 minutes after the Skriware 3D Printer finishes operating.



Moving mechanical elements

Never reach into the Skriware 3D Printer's work area and be careful around it, while it operates. **Extruder's gantry system** uses mighty engine that may pull in a piece of clothing or clip a body part.



Risk of electrocution

Skriware 3D Printer requires electric power to operate. Always connect the power cable to a grounded **power socket**. Never perform any maintenance while it is connected to a power socket unless it is specifically stated otherwise in this manual.



Dangerous vapours

Skriware 3D Printer has been designed to print with PLA filaments which are considered safe. However, it is still advised to use your Skriware 3D Printer in a well ventilated area. Depending on a type of filament, some dangerous vapours can still be released during a print process. Use other than officially supported filaments at own risk.



Electromagnetic and radio interference

Skriware 3D Printer is an electronic device and may cause radio and television interference. It also utilizes Wi-Fi radio which may cause disruptions in certain environments.

2. Printing materials

Skriware 3D Printer utilizes environment-friendly and safe 1.75 mm PLA filaments. Supported temperatures of printing for this materials range from 180°C (356°F) to 210°C (410°F). At this moment ABS filaments are not supported due to the non-heated **magnetic bed** of the Skriware 3D Printer so your results with this kind of material may vary.

Although Skriware 3D Printer supports other PLA 1.75 mm filaments, for best effects we suggest using the highest quality filaments provided by us. You can buy them directly from us at info@skriware.com.

 PLA  1.75 mm

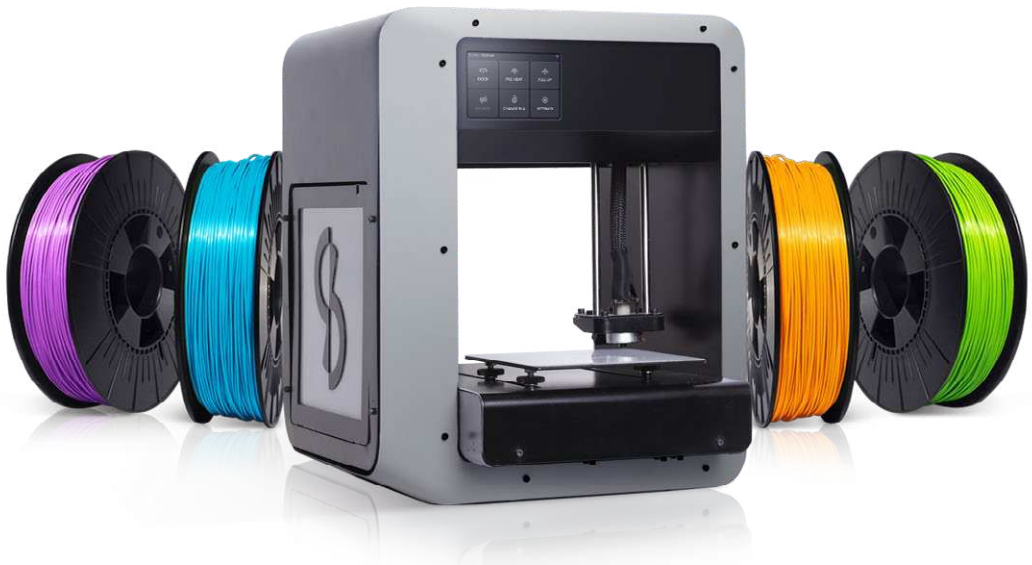

3. Overview

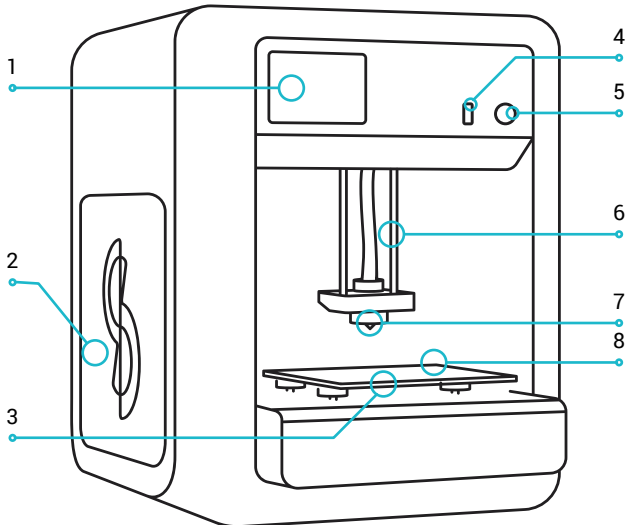

- 1. Display
- 2. Side panel
- 3. Printing platform
- 4. USB port
- 5. Power button
- 6. Extruder's gantry system
- 7. Hotend
- 8. Magnetic bed

- 1. Ethernet port
- 2. Printer's power socket
- 3. Power cable
- 4. Filament spool
- 5. Spool holder
- 6. Side panel
- 7. Power switch

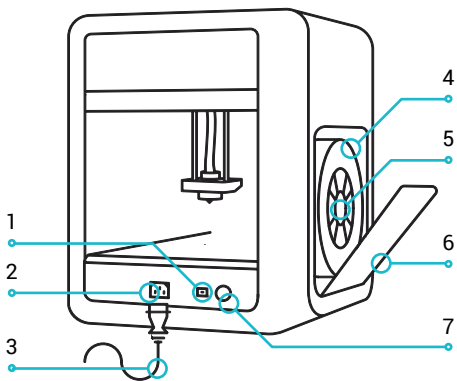

4. First set up

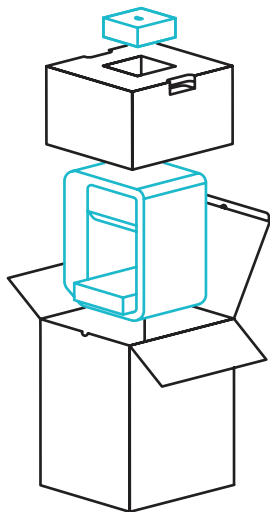

We know you are eager to get right to the 3D printing so here is a step by step guide to get you started. If you are as excited as we are, we encourage you to film your unboxing, setting up or first print and to upload the video to the YouTube, live-Tweet it with **#Skriware** or show it off to your Facebook friends. Go nuts! We will surely appreciate it.

Inside the opened box, on the top, you will find a small box containing quick start guide, 2 **magnetic beds**, the **power cable** and an additional **hotend**. If you are an advanced user or have previous experiences with 3D printing you can refer to the quick start guide to get you started immediately.

Carefully take out your Skriware 3D Printer from the box (**do not pull the black cord with the yellow warning sticker - it is not a handle!**) and place it on the designated working surface. Make sure it is stable and level.

Remove the foams securing the **extruder's gantry system** in place and another preventing the **printing platform** from moving. The foams may come in handy in the future if you plan to move your Skriware 3D Printer around.

Place one of the **magnetic beds** evenly on the **printing platform** and wipe it with a clean cloth and a rubbing alcohol.

Plug the **power cable** into the **printer's power socket** and into a grounded power socket near the Skriware 3D Printer's workplace and then set the **power switch** on the back of the printer to 1 (ON) position.

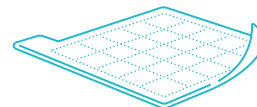

Press the **power button** on the Skriware 3D Printer's front.

Your Skriware 3D Printer will now turn on. Wait until the Skriware logo disappears from the **display** and you will see the main menu screen.

Connect your Skriware 3D Printer to a network

First thing you will want to do is to connect your Skriware 3D Printer to a network. You can do it by plugging ethernet cable in the **ethernet port** on the back of your Skriware 3D Printer or by joining a wireless network. To do so press **SETTINGS** in the main menu on the **display**, then **NETWORK** and **CONNECT TO WI-FI**. Skriware 3D Printer will now scan for your Wi-Fi network. Choose the one you want to connect to from the displayed list and input your Wi-Fi password. Skriware 3D Printer will confirm the successful connection via blue Wi-Fi or ethernet icon in the the top right corner of the **display**.

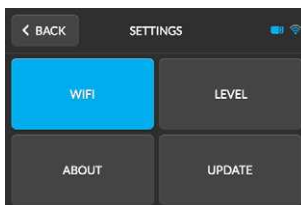
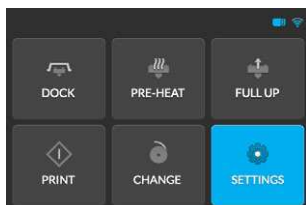

Pair with Skrimarket

To pair your Skriware 3D Printer with the **Skrimarket** go to **www.skrimarket.com** and create a new account. After you log in click a printer icon on the top of the page and input a serial code that you will find in **SETTINGS -> ABOUT** on your Skriware 3D Printer.

Level the printing platform

The **printing platform** comes pre-levelled. However, it is possible that it has moved during the delivery and it needs an alignment. Go to **SETTINGS**, then **LEVEL** and follow the instructions on the **display**.

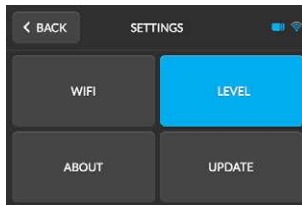
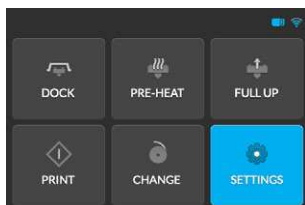

Press **< DONE** after you make sure that all the 3 dials are adjusted correctly. (in case of doubts refer to section 10. Levelling The Printing Platform on page 17)

! **Levelling dials are located under the printing platform. They may seem difficult to turn at first.**

Run a test

Your Skriware 3D Printer comes preloaded with a filament of your choice. Run a test print to ensure everything was set up correctly. To do it press **PRINT** in the main menu and then **REPRINT LAST MODEL**.

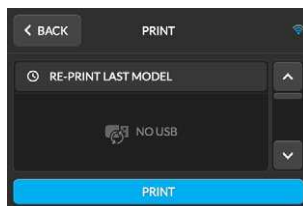
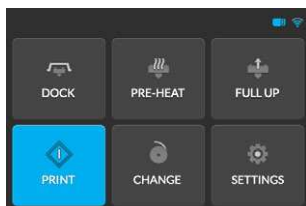

Voila! You are now ready to start an adventure with your very own Skriware 3D Printer.

5. Main menu



DOCK

DOCK

Docks the **printing platform** in the front of the Sftware 3D Printer and **extruder's gantry system** in the bottom right position.



PRE-HEAT

PRE-HEAT

Preheats the **extruder** to 190°C / 374°F and maintains this temperature for about 5 minutes unless you press **CANCEL** (be careful! Make sure the **HOT!** sign disappears before doing anything in the **extruder's** vicinity).



FULL UP

FULL UP

Docks the **printing platform** in the front of the Sftware 3D Printer and **extruder's gantry system** in the top right position.



PRINT

PRINT

Main USB drive 3D printing menu. More on p. 11.



CHANGE

CHANGE

Follow the on-screen instructions to change a filament. More on p. 13.



SETTINGS

SETTINGS (more on p. 15)

Network settings (p. 16), levelling the **printing platform** (p. 17), about and update (p. 15).

6. 3D printing

If it has been a while since the last time you used your Skriware 3D Printer or you have moved it around, you may want to level the **printing platform** (follow the instructions in the section 10. Levelling The Printing Platform on page 17) and wipe the **magnetic bed** with a rubbing alcohol and a clean cloth.

PRINTING FROM THE SKRIMARKET

For hassle-free 3D printing experience you will need a **Skrimarket** account and a Skriware 3D Printer paired with it. To do it go to **www.skrimarket.com** and create a new account. Follow the instructions online to register via e-mail or Facebook. After you log in click a printer icon on the top of the page and input a serial code that you will find in **SETTINGS -> ABOUT** on your Skriware 3D Printer. Confirm the pairing on the display.



You can now browse the **Skrimarket** and print any model available simply by pressing Print on the model's page. You will see a progress of your print next to the printer icon on **Skrimarket** and a pop-up prompt after it has finished.

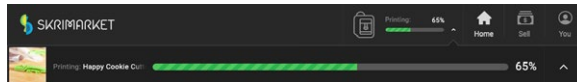

⚠ After a finished print you will need to remove the printed model from the magnetic bed and confirm it with OK prompt on your Skriware 3D Printer's display before printing another model.

If you are planning to print remotely remember to place the **magnetic bed** evenly on the **printing platform** and to check if there is enough filament left for your chosen model!

PRINTING FROM USB

Insert a USB drive into the **USB port** in front of your Sskriware 3D Printer and press **PRINT** in the main menu. Choose your desired model from the list of the files and confirm with the **PRINT** prompt on the bottom of the **display** (make sure the file is in the **gcode** format).

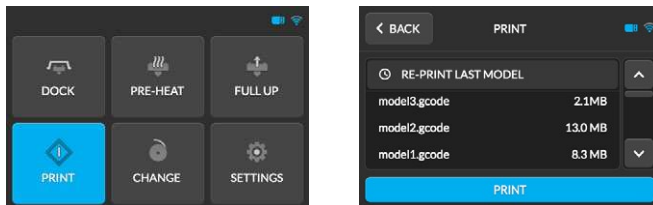

The Sskriware 3D Printer is now heating up. Current and target temperature and the name of your model's file will be shown on the display. Switch the displayed temperature units between Celsius and Fahrenheit by pressing on the **Current temperature** or **Target temperature**). You can cancel the process anytime by clicking the **< CANCEL** prompt in the top left of the **display**.

After the heating process finishes, your Sskriware 3D Printer will start printing the model. You will see current temperature, time elapsed and the progress bar with a percentage reading (press each for an alternative information). You can **< CANCEL** the print anytime or **PAUSE** it. If you **PAUSE** wait a little for the Sskriware 3D Printer to come to a full stop. Press **CONTINUE** to resume printing.

⚠ Be aware that pausing mid-print may cause your model to have a visible mark in the place that the extruder has paused and resumed printing.

PRINT FINISHED IN: prompt will be displayed after your model has finished printing. Wait until the **extruder** has cooled down (**HOT!** will no longer be seen on the display) before removing the **magnetic bed** with your model on it from the **printing platform**. Your model should come off the **magnetic bed** easily (you can bend the magnetic bed slightly to help it come off).

Press OK to confirm that you have taken a model off the **magnetic bed** and your Sskriware 3D Printer is ready for another print.

7. Changing a filament

UNLOADING A FILAMENT

To unload a filament press **CHANGE** in the main menu. Confirm on the prompt. Wait until the **extruder** heats up. You can **<CANCEL** the process anytime.

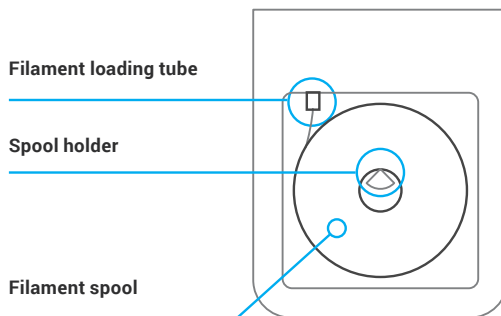
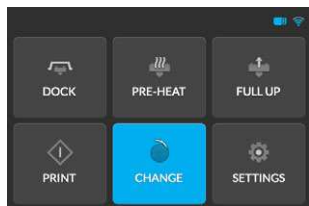

 **Do not touch the extruder and its vicinities while HOT! warning is displayed!**



The filament will now unload. It should take about a minute. When it has finished open the side panel and pull out the remaining filament out from the **filament loading tube**, take off the filament spool from the **spool holder** and press **CONTINUE** on the **display**.



You will now be asked if you want to load a new filament. Click **YES** if you do and follow the instructions.

LOADING A FILAMENT



Cut the end of a new filament at an angle. It will be easier to insert if it has a sharp tip. Press **CONTINUE**.



Put a filament spool on the **spool holder** as shown on the diagram on the **display** and push the cut end into the **filament loading tube** for about 10 cm (4 in) until you feel it won't go in anymore. Press **CONTINUE**. Keep pushing the filament lightly until you feel it being pulled into the **filament loading tube**.

 **Do not push filament forcefully! Once you feel that the motor is pulling in the filament by itself do not push anymore!**

Wait until you see the new filament coming out of the **hotend** and press **CONTINUE**. Confirm with **CONTINUE** again. Wait until **HOT!** Icon disappears from the **display** before removing the extruded filament.

10. Settings

WIFI

WI-FI

Set up your Wi-Fi network connection and see network information. More on p. 16

LEVEL

LEVEL

Follow the on-screen instructions to level the **printing platform**. More on p. 17

ABOUT

ABOUT

Your Skriware 3D Printer's unique code needed to pair with the **Skrimarket** is here. Also a little bit more about us and how to contact us!

UPDATE

UPDATE

Your satisfaction is paramount to us so we will be adding new features and squashing bugs via updates. Your Skriware 3D Printer checks for them every time it turns on but in case you missed it you will be able to find them in this menu. Simply press **SETTINGS -> UPDATE** and if an update is available press **YES** to download and install it. Wait until the Skriware 3D Printer reboots and you are ready to resume your hassle-free 3D printing experience.

11. Setting up a network connection

Your Skriware 3D Printer needs an Internet connection to connect to the **Skrimarket** for your hassles 3D printing experience. It offers both wired and wireless connection. Current type of connection is indicated by the icon in the top right of the **display**.

To establish a wired connection simply plug an ethernet cable into the **ethernet port** on the back of your Skriware 3D Printer.

To connect wirelessly press **SETTINGS** in the main menu, then **NETWORK** and **CONNECT TO WI-FI** after that. Your Skriware 3D Printer will scan for available networks. Choose a desired one from the list and press **CONNECT**.

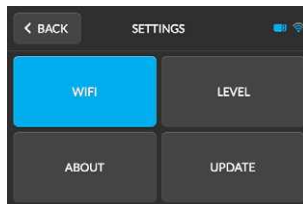
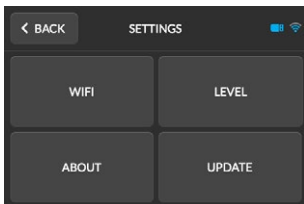

Input your Wi-Fi network password and confirm with **CONNECT**. You should see the **You have been successfully connected to the network** prompt. Confirm with **OK**.

In the **NETWORK** menu you can also see your **NETWORK STATS** (type of connection, IP address, SSID, signal strength and bitrate) and status of connection to the **Skrimarket** in **NETWORK TEST**.

12. Levelling the printing platform

In order for your models to turn out exactly the way you want them to, it is important that the **printing platform** is levelled. Before you follow the instruction of the levelling process you will need a standard piece of paper.

! Levelling dials are located under the printing platform. They may seem difficult to turn at first.

In the main menu go to **SETTINGS**, then press **LEVEL**. Read the prompt and click **CONTINUE**. All three **dials** need to be adjusted in the way shown on the **display** so that the piece of paper can slide between the **magnetic bed** and the **hotend** with a little bit of resistance. Keep pressing **CONTINUE** and adjusting the **dials** until you are sure they are set up correctly. Press **< DONE** when you are finished.

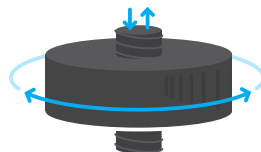
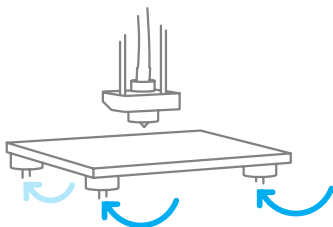
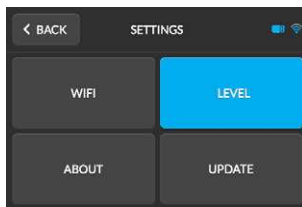
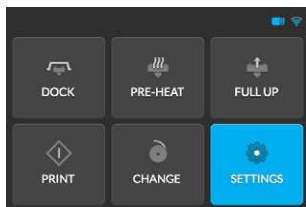

13. Maintenance

Action	Frequency	Detailed explanation
Cleaning the magnetic bed	Before every print	Clean the top white side of the magnetic bed with a clean cloth and rubbing alcohol
Leveling the printing platform	Every couple of prints / each time you have moved the printer	page 17

14. Specification

Printer

Printer control

Full Color Touchscreen

Material type

PLA

File transfer

Wifi, Ethernet, USB port and Skrimarket

Dimensions

330 mm (w) x 345 mm (d) x 425 mm (h)

13,0 in (w) x 14,8 in (d) x 16,7 in (h)

Operating temperature

10-30°C

50-86°F

Print properties

Print area

150 mm (w) x 150 mm (d) x 130 mm (h)

5,9 in (w) x 5,9 in (d) x 5,1 in (h)

Material diameter

1,75 mm

0,007 in

Maximum nozzle temperature

235°C

455°F

Supports

Automatically generated, easily removable

15. Troubleshooting

Symptom

Possible solution

I can't find my Wi-Fi network

Check if your router is working and your other devices can connect to it. Skriware 3D Printer does not support 5GHz networks

My Skriware 3D Printer isn't working

Make sure the **power cable** is connected, the **power switch** is in "1" position and press the **power button**

My model doesn't stick to the **magnetic bed**

Clean the **magnetic bed** with a clean cloth and rubbing alcohol. Reattach it evenly on the **printing platform**

I can't load a filament.

Run a filament unloading process again. Cut a filament at the end and make sure it is not bent

16. Contact

If you need to contact us in regard to technical or any matter do not hesitate!

You can reach us by mail on info@skriware.com or message us on Facebook [facebook.com/skriware](https://www.facebook.com/skriware)

For all the technical issues write to support@skriware.com .

Enjoy your Skriware 3D Printer!

Yours,
Skriware Team